



EN Daylight therapy lamp	
Instruction for use	2
ELECTROMAGNETIC COMPATIBILITY	
INFORMATION	9

Content

1. About the daylight therapy lamp	2	8. Storage	6
2. Signs and symbols	3	9. Disposal.....	7
3. Notes	3	10. What if there are problems?	7
4. Unit description	4	11. Technical specifications	7
5. Initial use	5	12. Mains part.....	7
6. Operation.....	5	13. Warranty Conditions.....	8
7. Cleaning and care of the unit	6		

1. About the daylight therapy lamp

Dear valued customer,

Thank you for choosing one of our products. Our name stands for high-quality, thoroughly tested products for applications in the areas of heat, weight, blood pressure, body temperature, pulse, gentle therapy, massage and air.

With kind regards
Your Beurer team

Why use a daylight therapy lamp?

Intended Use

The intended use of the Light Therapy Lamp is to provide light source to offer a kind of “Light therapy” function in which the artificial light environment would provide end user with sense of relax or help them to ease depression, or treat seasonal affective disorder. Many people regularly experience lack of energy throughout the day, this product can be used to boost them and let them feel more energetic by suppressing sleep hormone inside body. When the hours of daylight are noticeably decreased in autumn and people increasingly stay inside, the effects of a lack of light may cumulate. This is often described as „winter depression“. The symptoms can present themselves in a number of ways:

- Imbalance
- Need for more sleep
- Subdued mood
- Loss of appetite
- Lack of energy and listlessness
- Difficulty concentrating
- Generally feeling under the weather















The cause of these symptoms is the fact that light, particularly sunlight, is essential for life and has a direct effect upon the human body. Sunlight indirectly controls the production of melatonin, which is released into the blood only in darkness. This hormone tells the body when it is time to sleep. In the months when there is less sunlight, therefore, production of melatonin increases. This makes it harder to get up in the morning, since the body’s functions are shut down. If you use the daylight therapy lamp immediately after waking up in the morning—thus as early as possible—you can end the production of melatonin so that your mood can take positive turn. In addition, light deficiency also hinders production of the happiness hormone serotonin, which decisively affects our well-being. So application of light involves quantitative changes in hormones and neurotransmitters in the brain, which can affect our level of activity, our feelings and our well-being. Light can help reverse this hormone imbalance. To compensate for such a hormonal imbalance, the daylight therapy lamp can create a suitable replacement for natural sunlight.

In the medical field, daylight therapy lamps are used to compensate for the effects of a lack of light. Daylight therapy lamps simulate daylight over 10,000 lux. The light can influence the human body and be used as a treatment or as a preventative measure. Normal electric light is not sufficient to influence the hormonal balance. Because in a well-lit office the illuminance level amounts to just 500 lux.

- Included in delivery:**
- Daylight therapy lamp
 - Mains part
 - These operating instructions

2. Signs and symbols

The following symbols appear in these instructions or on the device.

	Read the instructions of use		Permissible operating temperature and humidity
 Warning	Warning instruction indicating a risk of injury or damage to health.	 Note	Note on important information
 Important	Safety note indicating possible damage to the unit/accessory.		Manufacturer
	Serial number		Device in protection class 2
	The CE labelling certifies that the product complies with the essential requirements of Directive 93/42/EEC on medical products.		OFF / ON
	Disposal in accordance with the Waste Electrical and Electronic Equipment EC Directive – WEEE	IP21	Protected against solid foreign objects 12.5 mm in diameter and larger, and against vertically falling drops of water
	Direct current	IP22	Protected against solid foreign objects 12.5 mm in diameter and larger, and against drops of water when the housing is angled up to 15°
 Storage	Permissible storage temperature and humidity		Dispose of packaging in an environmentally friendly manner

3. Notes

Please read these instructions for use carefully and keep them for later use, be sure to make them accessible to other users and observe the information they contain.

Safety notes

Warning

- The light of the daylight therapy lamp is only intended for use on the human body.
- Before use, ensure that all packaging materials are removed and that there is no visible damage to the unit or accessories. When in doubt, do not use the unit and contact your dealer or the customer service address provided.
- Also ensure that the daylight therapy lamp has a firm footing.
- Connect the unit only to the mains voltage listed on the type plate.
- Do not dip the unit into water and do not use it in wet rooms.
- Do not use it in the vicinity of people who are helpless, children under age 3 or people who are insensitive to heat (people with skin lesions due to illness); do not use after taking painkillers or drugs or drinking alcohol.
- Keep children away from packaging materials (risk of suffocation).
- Do not cover up or pack away the unit while it is warm.
- Always unplug the mains part and allow the device to cool down before touching it.
- Do not touch the unit with wet hands while it is plugged in; do not allow any water to be sprayed onto the unit. The unit must be operated only when it is completely dry.
- Ensure that you only insert and remove the mains part with dry hands and that you only press the ON/OFF button with dry hands.
- Keep the mains cable away from hot objects and naked flames.

- Danger of strangulation due to excessively long cables.
- Protect the unit from strong impacts.
- Do not pull the mains part out of the socket using the mains cable.
- If the mains part or its housing is damaged, this must be replaced by customer services or the retailer, as a special tool is needed for repair.
- Disconnection from the power supply network is only guaranteed when the mains part is unplugged.
- Do not use the device in the presence of flammable anaesthetic gas connections with air, oxygen or nitrogen oxide.
- No calibration and no preventative checks or maintenance is to be carried out on this device.
- You cannot repair the device. The device contains no parts that you can repair.
- Do not make any changes to the device without the manufacturer's permission.
- If the device has been changed, thorough tests and checks must be carried out to ensure the continued safety of further use of the device.
- Do not position the device in a location where it is difficult to disconnect it from the mains supply.
- Check the device before each use. Do not use the device if it is damaged in any way.
The continuous use of a damaged unit can be dangerous and may cause injury or improper results.
- The main material of the case is made of PC/ABS. Be cautious of potential allergic reactions to these materials.

General notes

⚠ Important

- If you are taking medication such as pain relievers, antihypertensives or antidepressants, consult your doctor before using the daylight therapy lamp.
- People with retinal diseases as well as diabetics need to be examined by an ophthalmologist before beginning to use the daylight therapy lamp.
- Please do not use if you have an eye disease such as cataracts, glaucoma, diseases of the optic nerve in general and inflammation of the vitreous humour.
- If you have health concerns of any kind, contact your general practitioner!
- Before you use the unit for the first time, remove all packaging materials.
- The lamp tubes are excluded from the warranty.

Repairs

⚠ Important

- Do not open the device. Please do not attempt to repair the unit yourself. This could result in serious injuries. Failure to observe this regulation shall void the warranty.
- If you need to have the unit repaired, contact customer service or an authorised dealer.

4. Unit description

Overview

1. Fluorescent screen
2. Rear of the device housing
3. On/Off button
4. Mains part connector
5. Timer adjustment „- / +“
6. Timer LED display
7. Brightness adjustment (dimmer)

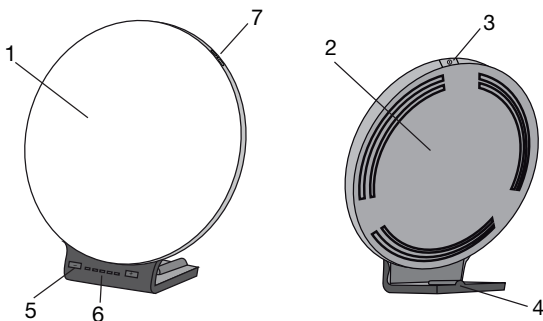

5. Initial use

Take the device out of the plastic wrapping. Check the device for damage or faults. If you notice any damage or faults on the device, do not use it and contact customer services or your supplier.

Positioning the device

Place the device on an even surface. The position should be chosen to ensure a distance of between 10 cm and 40 cm between the user and the device. The lamp is most effective at this distance.

Mains connection



- To prevent possible damage to the device, the daylight therapy lamp must only be used with the mains part described here.
- Insert the mains part into the connection provided for this purpose on the rear of the daylight therapy lamp. The mains part must only be connected to the mains voltage that is specified on the type plate.
- After using the daylight therapy lamp, unplug the mains part from the mains socket first and then disconnect it from the daylight therapy lamp.

Note:

- Ensure that there is a socket near the place where the lamp will stand.
- Lay the mains cable in such a way that no one can trip over it.

6. Operation

1	Insert the mains part into the connector.												
2	Switch on the light ▶ Press the ON/OFF button.												
3	LED display/timer The daylight therapy lamp TL 70 indicates your current treatment time with the aid of 5 LEDs. The treatment time can be set at the following 5 levels. The timer function is not activated when the light is switched on for the first time. The light now shines until it is switched off again or a treatment time is set (timer = 0 min). In order to use the timer, set the desired level from 1 to 5 using the „+/-“ buttons. On level 1, a treatment time of 15 minutes is set. The other levels are as follows: <table border="1" data-bbox="136 880 785 1070"><thead><tr><th>Treatment time</th><th>Number of lit LEDs</th></tr></thead><tbody><tr><td>15 Minutes</td><td>1</td></tr><tr><td>30 Minutes</td><td>2</td></tr><tr><td>45 Minutes</td><td>3</td></tr><tr><td>90 Minutes</td><td>4</td></tr><tr><td>120 Minutes</td><td>5</td></tr></tbody></table> The light switches off automatically after this treatment time. If you wish to deactivate the timer function, you can press the „-“ button until the LEDs go out.	Treatment time	Number of lit LEDs	15 Minutes	1	30 Minutes	2	45 Minutes	3	90 Minutes	4	120 Minutes	5
Treatment time	Number of lit LEDs												
15 Minutes	1												
30 Minutes	2												
45 Minutes	3												
90 Minutes	4												
120 Minutes	5												
4	Brightness adjustment The daylight therapy lamp TL 70 has 10 brightness levels. The desired brightness level can be set using the „+/-“ buttons on the side – this level should be set so that it is pleasant for the eye during the treatment. When the device is switched off, the last level that was set is saved. When the device is next switched on, it restarts with the saved brightness level.												

5	<p>Enjoying the light</p> <p>Sit as close as possible to the lamp, between 10 cm and 40 cm. You can go about your normal activities while using it. You can read, write, make telephone calls, etc.</p> <ul style="list-style-type: none"> • Every so often, briefly look directly into the light, since the effect results from the eyes/ retina receiving the light. • Use the daylight therapy lamp as often as you want. However, the treatment is at its most effective if you carry out the light therapy according to the prescribed time period of at least 7 successive days. • The most effective time of day for the treatment is between 6am and 8pm and we recommend that it is used for 2 hours per day. • Do not look directly into the light the whole time you are using it, however, since that could lead to overstimulation of the retina. • Start with shorter periods of illumination, which you increase over the course of a week. <p> Note: Eye aches and headaches may arise after the first times using the lamp. These will go away in later sessions, as the nervous system will become accustomed to the new stimulation.</p>								
6	<p>Important instructions</p> <p>When using the lamp, maintain the recommended distance of 10 - 40 cm between your face and the lamp. The duration of the application depends on the distance:</p> <table border="1" data-bbox="140 563 546 710"> <thead> <tr> <th>Distance</th> <th>Duration</th> </tr> </thead> <tbody> <tr> <td>Up to 10 cm</td> <td>½ hour/day</td> </tr> <tr> <td>Up to 25 cm</td> <td>1 hour/day</td> </tr> <tr> <td>Up to 40 cm</td> <td>2 hours/day</td> </tr> </tbody> </table> <p>Basically, the closer you are to the source of light, the less time you should use it.</p>	Distance	Duration	Up to 10 cm	½ hour/day	Up to 25 cm	1 hour/day	Up to 40 cm	2 hours/day
Distance	Duration								
Up to 10 cm	½ hour/day								
Up to 25 cm	1 hour/day								
Up to 40 cm	2 hours/day								
7	<p>Enjoying light over longer periods</p> <p>Repeat your use of the lamp in the dark seasons for at least 7 successive days, or even longer, depending on your individual needs. If possible, conduct the treatment in the morning hours.</p>								
8	<p>Switching off the lamp</p> <p>▶ Press the On/Off button. The LEDs switch off. Unplug the mains part from the mains socket.</p> <p> CAUTION! The light remains hot after use.. Let the lamp cool off first long enough before you put it away and/or pack it up!</p>								

7. Cleaning and care of the unit

The unit should be cleaned occasionally.

Important

- Ensure that no water penetrates inside the unit!
Before you clean the unit, always switch it off, unplug it and let it cool off.
- Do not wash the unit in a washing machine!
Use a slightly damp cloth to clean the device.
- Do not touch the unit with wet hands while it is plugged in; do not allow any water to be sprayed onto the unit. The unit must be operated only when it is completely dry.
Do not use abrasive detergents and never immerse the unit in water.

8. Storage

If you are not going to use the device for an extended period of time, disconnect it and store it in a dry place, out of the reach of children.

Follow the storage instructions provided in the “Technical data” chapter.

9. Disposal

For environmental reasons, do not dispose of the device in the household waste at the end of its useful life. Dispose of the unit at a suitable local collection or recycling point. Dispose of the device in accordance with EC Directive – WEEE (Waste Electrical and Electronic Equipment). If you have any questions, please contact the local authorities responsible for waste disposal.



10. What if there are problems?

Problem	Possible cause	Solution
Device does not light up	On/off button switched off	Switch on the on/off button.
	No electricity	Connect the mains part properly.
	No electricity	The mains part is faulty. Contact customer services or your retailer.
	LEDs have reached the end of their service life. LEDs faulty.	If you need to have the unit repaired, contact customer service or an authorised dealer.

11. Technical specifications

Model no.	TL 70
Dimensions (WHD)	366 x 335 x 203 mm
Weight	1130 g (1240 g incl. mains adapter)
Lighting elements	LED
Power	36 Watts
Light intensity	10.000 lux (Distance: approx. 10 cm)
Operating conditions	+5°C to +35°C, 15 - 90% relative humidity atmospheric pressure range 86-106 kpa
Storage conditions	-20 °C to +50 °C, 15 - 90% relative humidity atmospheric pressure range 86-106 kpa
Product classification	External power supply, Protection class II, IP21
Color temperature of LEDs	5.300 Kelvin (+/- 300 K)
Included in delivery	Daylight therapy lamp, Mains part, These operating instructions

Subject to technical modifications.

The serial number is located on the device or in the battery compartment.

This device meets the requirements of the European Directive 93/42/EEC and 2007/47/EC Medical Devices as well as the Medical Devices Act.

This device complies with European Standard EN60601-1-2 and is subject to particular precautions with regard to electromagnetic compatibility. Please note that portable and mobile HF communication systems may interfere with this unit. More details can be requested from the stated Customer Service address or found at the end of the instructions for use.

12. Mains part

Model no.	MP45 – 240150 – AG
Input	100–240 V ~ 50/60 Hz
Output	24 V DC, 1.5A, only in connection with TL 70
Protection	The device is double protected and therefore corresponds to protection class 2, protection class II

	Polarity of the the DC voltage connection
Classification	IP22

13. WARRANTY CONDITIONS

Beurer GmbH, Söflinger Straße 218, 89077 Ulm, Germany (hereinafter referred to as “Beurer”) provides a warranty for this product, subject to the requirements below and to the extent described as follows.

The warranty conditions below shall not affect the seller’s statutory warranty obligations which ensue from the sales agreement with the buyer.

The warranty shall apply without prejudice to any mandatory statutory provisions on liability.

Beurer guarantees the perfect functionality and completeness of this product.

The worldwide warranty period is 3 years, commencing from the purchase of the new, unused product from the seller.

The warranty only applies to products purchased by the buyer as a consumer and used exclusively for personal purposes in the context of domestic use.

German law shall apply.

During the warranty period, should this product prove to be incomplete or defective in functionality in accordance with the following provisions, Beurer shall carry out a repair or a replacement delivery free of charge, in accordance with these warranty conditions.

If the buyer wishes to make a warranty claim, they should approach their local retailer in the first instance: see the attached “International Service” list of service addresses.

The buyer will then receive further information about the processing of the warranty claim, e.g. where they can send the product and what documentation is required.

A warranty claim shall only be considered if the buyer can provide Beurer, or an authorised Beurer partner, with

- a copy of the invoice/purchase receipt, and
- the original product.

The following are explicitly excluded from this warranty:

- deterioration due to normal use or consumption of the product;
- accessories supplied with this product which are worn out or used up through proper use (e.g. batteries, rechargeable batteries, cuffs, seals, electrodes, light sources, attachments and nebuliser accessories);
- products that are used, cleaned, stored or maintained improperly and/or contrary to the provisions of the instructions for use, as well as products that have been opened, repaired or modified by the buyer or by a service centre not authorised by Beurer;
- damage that arises during transport between manufacturer and customer, or between service centre and customer;
- products purchased as seconds or as used goods;
- consequential damage arising from a fault in this product (however, in this case, claims may exist arising from product liability or other compulsory statutory liability provisions).

Repairs or an exchange in full do not extend the warranty period under any circumstances.

ELECTROMAGNETIC COMPATIBILITY INFORMATION

Technical Description Concerning Electromagnetic Emission

Table 1: Declaration - electromagnetic emissions

Guidance and manufacturer's declaration - electromagnetic emissions		
The model TL 70 is intended for use in the electromagnetic environment specified below. The customer or the user should assure that it is used in such an environment.		
Emissions test	Compliance	Electromagnetic environment – guidance
RF emissions CISPR 11	Group 1	The models TL 70 use RF energy only for its internal function. Therefore, its RF emissions are very low and are not likely to cause any interference in nearby electronic equipment.
RF emissions CISPR 11	Class B	The model TL 70 is suitable for used in domestic establishment and in establishment directly connected to a low voltage power supply network which supplies buildings used for domestic purposes.
Harmonic emissions IEC 61000-3-2	Class C	
Voltage fluctuations/ flicker emissions IEC 61000-3-3	Not applicable	

Technical Description Concerning Electromagnetic Emission

Table 1: Declaration - electromagnetic emissions

Guidance and manufacturer's declaration – electromagnetic immunity			
The TL 70 is intended for use in the electromagnetic environment specified below. The customer or the user should assure that it is used in such an environment.			
Immunity test	IEC 60601 test level	Compliance level	Electromagnetic environment – guidance
Electrostatic discharge (ESD) IEC 61000-4-2	±8 kV contact ±15 kV air	±8 kV contact ±15 kV air	Floors should be wood, concrete or ceramic tile. If floors are covered with synthetic material, the relative humidity should be at least 30%
Electrical fast transient/burst IEC 61000-4-4	±2 kV for power supply lines ±1 kV for input/output lines	±2 kV for power supply lines	Mains power quality should be that of a typical commercial or hospital environment.
Surge IEC 61000-4-5	±1 kV line to line ±2 kV line to earth	±2 kV line to earth	Mains power quality should be that of a typical commercial or hospital environment.
Voltage dips, short interruptions and voltage variations on power supply input lines IEC 61000-4-11	<5% U_T (>95% dip in U_T) for 0.5 cycle 40% U_T (60% dip in U_T) for 5 cycles 70% U_T (30% dip in U_T) for 25 cycles <5% U_T (>95% dip in U_T) for 5 seconds	<5% U_T (>95% dip in U_T) for 0.5 cycle 40% U_T (60% dip in U_T) for 5 cycles 70% U_T (30% dip in U_T) for 25 cycles <5% U_T (>95% dip in U_T) for 5 seconds	Mains power quality should be that of a typical commercial or hospital environment. If the user of the model TL 70 requires continued operation during power mains interruptions, it is recommended that the TL 70 daylight therapy lamp is to be powered from an uninterruptible power supply or a battery.
Power Frequency (50/60HZ) magnetic field IEC 61000-4-8	3 A/m	Not applicable	Not applicable
NOTE U_T is the a.c. mains voltage prior to application of the test level.			

Table 3: Guidance & Declaration - electromagnetic immunity concerning Conducted RF & Radiated RF

Guidance and manufacturer's declaration – electromagnetic immunity			
The model TL 70 is intended for use in the electromagnetic environment specified below. The customer or the user should assure that it is used in such an environment.			
Immunity test	IEC 60601 test level	Compliance level	Electromagnetic environment – guidance
Conducted RF IEC 61000-4-6 Radiated RF IEC 61000-4-3	3 Vrms 150 kHz to 80 MHz 3 V/m 80 MHz to 2.5 GHz	3 V 3 V/m	<p>Portable and mobile RF communications equipment should be used no closer to any part of the model TL 70, including cables, than the recommended separation distance calculated from the equation applicable to the frequency of the transmitter.</p> <p>Recommended separation distance</p> <p>3V</p> <p>$d=1.2 \sqrt{P}$ 80MHz to 800MHz</p> <p>$d=2.3 \sqrt{P}$ 800MHz to 2.5 GHz</p> <p>where P is the maximum output power rating of the transmitter in watts (W) according to the transmitter manufacturer and d is the recommended separation distance in meters (m).</p> <p>Field strengths from fixed RF transmitters, as determined by an electromagnetic site survey,^a should be less than the compliance level in each frequency range.^b</p> <p>Interference may occur in the vicinity of equipment marked with the following symbol:</p> 
<p>NOTE 1 At 80 MHz end 800 MHz. the higher frequency range applies.</p> <p>NOTE 2 These guidelines may not apply in all situations. Electromagnetic propagation is affected by absorption and reflection from structures, objects and people.</p>			
<p>^a Field strengths from fixed transmitters, such as base stations for radio (cellular/cordless) telephones and land mobile radios, amateur radio, AM and FM radio broadcast and TV broadcast cannot be predicted theoretically with accuracy. To assess the electromagnetic environment due to fixed RF transmitters, an electromagnetic site survey should be considered. If the measured field strength in the location in which the model TL 70 is used exceeds the applicable RF compliance level above, the model TL 70 should be observed to verify normal operation. If abnormal performance is observed, additional measures may be necessary, such as reorienting or relocating the model TL 70.</p> <p>^b Over the frequency range 150 kHz to 80 MHz, field strengths should be less than 3V/m.</p>			

Table 4: Recommended separation distances between portable and mobile RF communications equipment and the model TL 70

Recommended separation distances between portable and mobile RF communications equipment and the model TL 70			
The model TL 70 is intended for use in electromagnetic environment in which radiated RF disturbances is controlled. The customer or the user of the model TL 70 can help prevent electromagnetic interference by maintaining a minimum distance between portable and mobile RF communications equipment (transmitters) and the model TL 70 as recommended below, according to the maximum output power of the communications equipment.			
Rated maximum output power of transmitter W	Separation distance according to frequency of transmitter m		
	150 kHz to 80 MHz $1.2 \sqrt{P}$	80 MHz to 800 MHz $1.2 \sqrt{P}$	800 MHz to 2,5 GHz $2.3 \sqrt{P}$
0.01	0.12	0.12	0.23
0.1	0.38	0.38	0.73
1	1.2	1.2	2.3
10	3.8	3.8	7.3
100	12	12	23
For transmitters rated at a maximum output power not listed above, the recommended separation distance <i>d</i> in meters (m) can be estimated using the equation applicable to the frequency of the transmitter, where <i>P</i> is the maximum output power rating of the transmitter in watts (W) accordable to the transmitter manufacturer.			
NOTE 1 At 80 MHz and 800 MHz. the separation distance for the higher frequency range applies.			
NOTE 2 These guidelines may not apply in all situations. Electromagnetic propagation is affected by absorption and reflection from structures, objects and people.			

 Dong Guan Q&S Electronic Manufacturing Company Ltd.
Yin Shan District, Fu Gang Village, Xiang Mang West Road, Qing Xi Town, Dong Guan City, P.R. China

Distributed by: Beurer GmbH • Söflinger Str. 218 • 89077 Ulm, Germany
Tel.: +49 (0)731 / 39 89-144 • Fax: +49 (0)731 / 39 89-255
www.beurer.com • Mail: kd@beurer.de

 MedNet GmbH, Borkstrasse 10, 48163 Münster, Germany

 0598